

AQUINOX - NIROSTA ÜBERFALLEN

9,80 € - 12,20 €

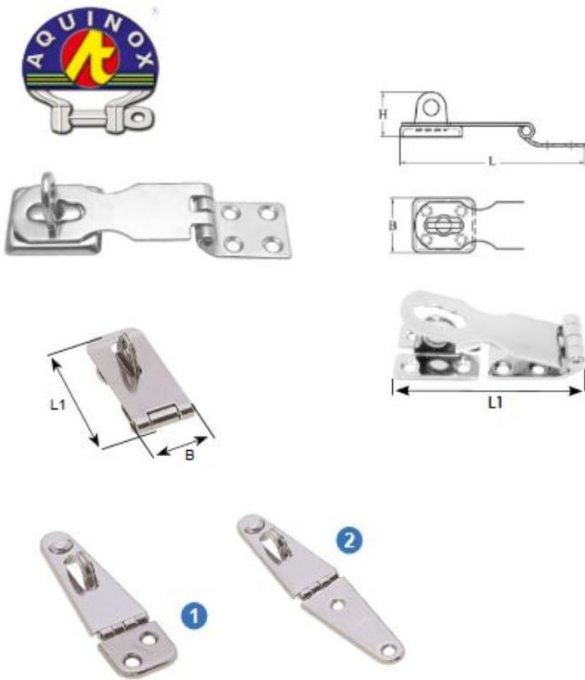



















Artikelnummer: 35729

Kategorien: [Edelstahlteile & Beschläge](#)



VARIATIONEN

Bild	Artikelnummer	Preis	Stock Status	Stock Quantity	Beschreibung Ausführung
	35729-01	12,20 €	Lieferzeit 2-5 Tage		Nr.2 mit starrem Auge, L mm 145

Bild	Artikelnummer	Preis	Stock Status	Stock Quantity	Beschreibung Ausführung
      	35729-02	10,40 €	Lieferzeit 2-5 Tage		Nr.1 mit starrem Auge, L mm 103
      	35729-03	9,80 €	Lieferzeit 2-5 Tage		mit starrem Auge, L mm 64
      	35729-04	11,10 €	Lieferzeit 2-5 Tage		mit verdrehbarem Auge, L mm 95

BESCHREIBUNG

AQUINOX - Nirosta Überfallen

Mit verdrehbarem Auge, Nirosta A4 / AISI 316

L mm	L1 mm	B mm	H mm	Schraubloch mm
95	70	28	23	4

Mit starrem Auge, Nirosta A4 / AISI 316

L mm	L1 mm	B mm	Schraubloch mm
64	50	32	5

Mit starrem Auge, Nirosta

Nr	L mm	B mm	Schraubloch mm
1	103	32	6
2	145	32	5

1